

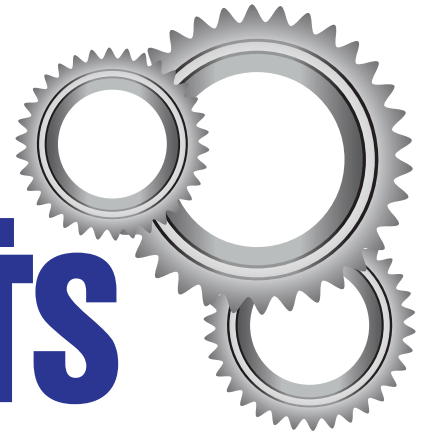

DIESEL PARTS



DIESEL PARTS PEÇAS AUTOMOTIVAS LTDA

CATÁLOGO DE PRODUTOS

Certificado BR19/10492

SGS

O sistema de gestão de

Diesel Parts Peças Automotivas Ltda.

Alameda Itanhaém, 391, Jardim Saira
Sorocaba, SP, 18085-180, BR

Foi auditado e certificado encontrando-se em conformidade com os requisitos da norma

ISO 9001:2015

Para as seguintes atividades

**Assembling and manufacturing of transmissions repair kits,
commercialization of components for transmissions, differential axles and
brake systems for heavy vehicles to auto parts companies.**

Informações adicionais a respeito do escopo e da aplicação dos requisitos da norma
ISO 9001:2015 podem ser obtidas consultando a organização

Este certificado é válido de 29 de maio de 2022 até 29 de maio de 2025
e mantém-se válido sujeito a auditorias de acompanhamento satisfatórias.

Auditoria de recertificação devida com, no mínimo, 60 dias de
antecedência da data de expiração.

Revisão 2. Certificado desde 30 de maio de 2019

A auditoria que deu origem a este certificado teve início em 26 de abril de 2022
O certificado anterior era válido até 29 de maio de 2022



Autorizado por

Thiago Doretto
Gerente Nacional



SGS do Brasil Ltda.
Av. Piracema, 1341 - Galpão Horizon
CEP 06460-030, Barueri/SP, Brasil
Fone: +55 11 2664-9595 / Fax: +55 11 3883-8904
www.sgsgroup.com.br

Accredited by Member of the International
Accreditation Forum Multilateral Recognition
Arrangement for Quality Management Systems

Página 1 de 1

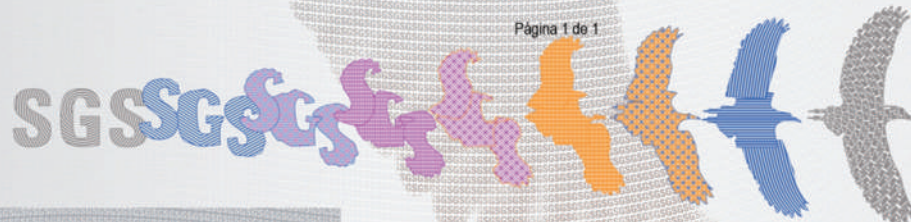

This document is a Web version of SGS certificate for electronic use exclusively. It shall only be available by clicking on SGS Certification Mark which has been posted on Your website. It shall not be printed in anyway. This document is copyright protected. No content or appearance may be reproduced without the express written permission of SGS. Any misuse, alteration, forgery or falsification is unlawful.

A Diesel Parts Peças Automotivas Ltda está atuando no mercado desde 2006 no fornecimento de peças para transmissões e eixos diferenciais da linha pesada, com forte presença no mercado nacional. Nosso portfólio de produtos inclui engrenagens, eixos, luvas, corpos, anéis sincronizados, jogos de reparo, entre outros componentes para os caminhões da linha pesada. A empresa garante elevados padrões de qualidade, equipe de vendas especializada e um alto nível de estoque para rapidez na entrega.



Nosso Objetivo é Distribuir Itens com o Melhor Valor Agregado e a Mais Perfeita Relação Custo-Benefício.

Possuímos o Sistema de Gestão da Qualidade de acordo com os requisitos estabelecidos na NBR ISO-9001: 2015;

Possuímos uma equipe de vendas especializada para suporte na hora da venda;

Trabalhamos com um alto nível de estoque para assegurar a disponibilidade para nossos clientes;

ATENDEMOS TODO O BRASIL.



Produtos

Atendemos as Principais Marcas
VOLVO, SCANIA, MERCEDES e ZF

JOGOS DE REPARO



DP035 / CAIXA MBB
Jogo de Reparo Completo
MBB G210 / G240

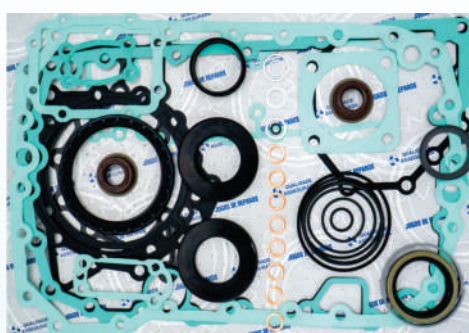

1315 298 003
Jogo de Reparo Completo
16S 221/2280

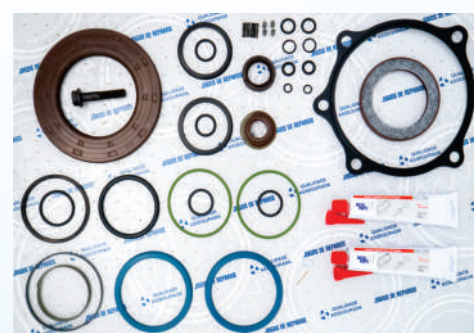

DP042 / CAIXA VOLVO
Jogo de Reparo Completo
VOLVO VT 2014 / 2214

EIXOS E ENGRENAGENS



EIXOS



**LUVAS
DE ENGATE**



ENGRENAGENS



**CORPOS
SINCROZADOS**

CANECAS E BOMBAS



**CANECA DA
TRANSFERÊNCIA**

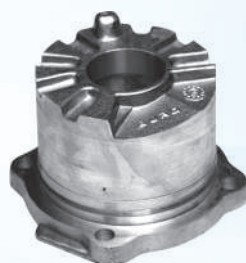

**CANECA DA
REDUZIDA**

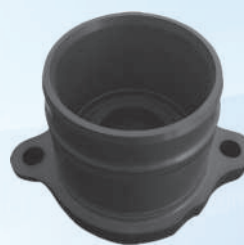

**CANECA
VOLVO**



**BOMBA
MERCEDES**

KITS DE REPARO PARA TRANSMISSÃO

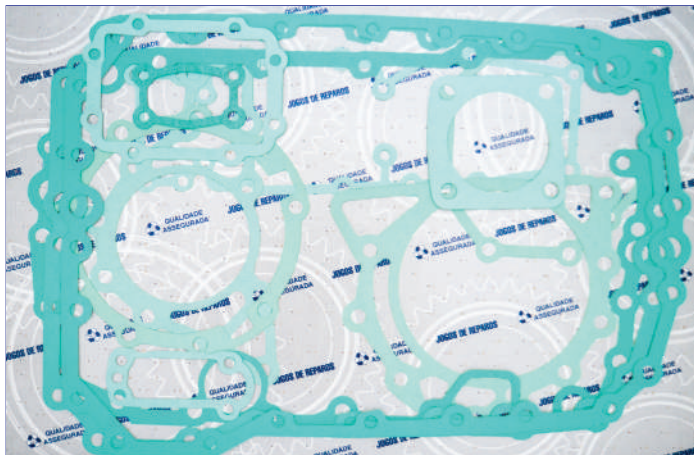

1295 298 891 – JOGO DE JUNTAS
8S-1350, 16S1300, 16S1600, 16S1650, 16S1900



1297 298 801 – JOGO DE REPARO COMPLETO
8S-1350, 16S-1650

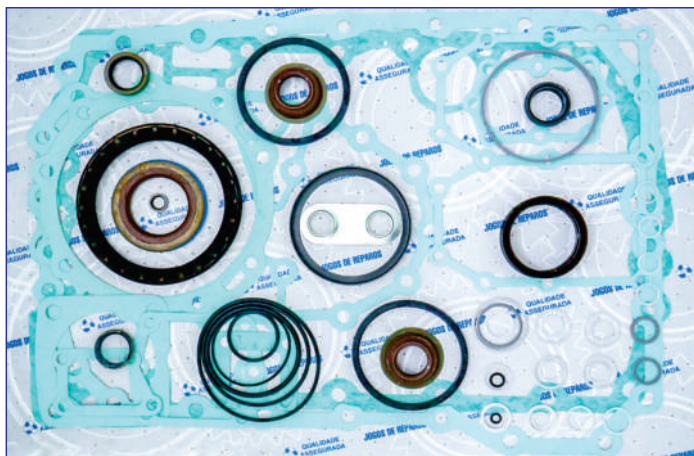

1295 298 875 – JOGO DE REPARO COMPLETO
16S1300

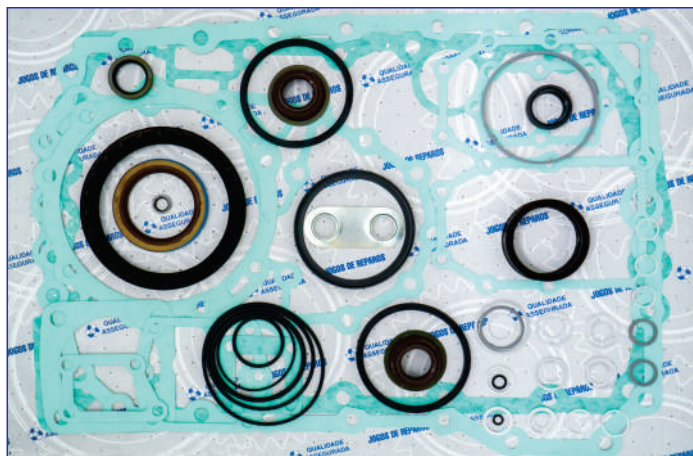

1295 298 874 – JOGO DE REPARO COMPLETO
16S1300, 16S1600, 16S1900

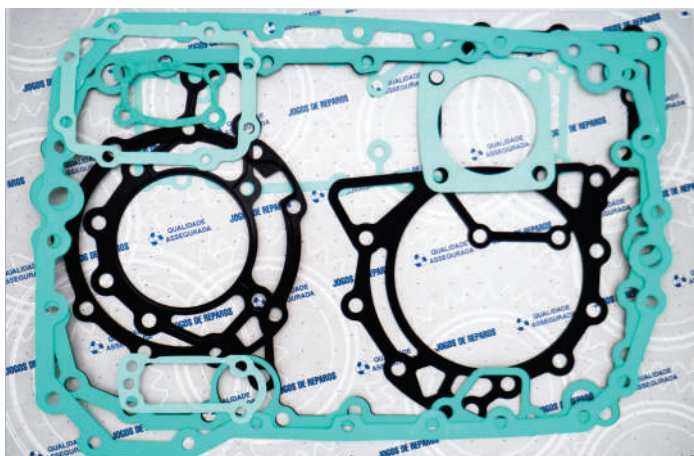

1315 298 001 – JOGO DE JUNTAS
16S221, 16S1585, 16S1685, 16S2280, 16S2320

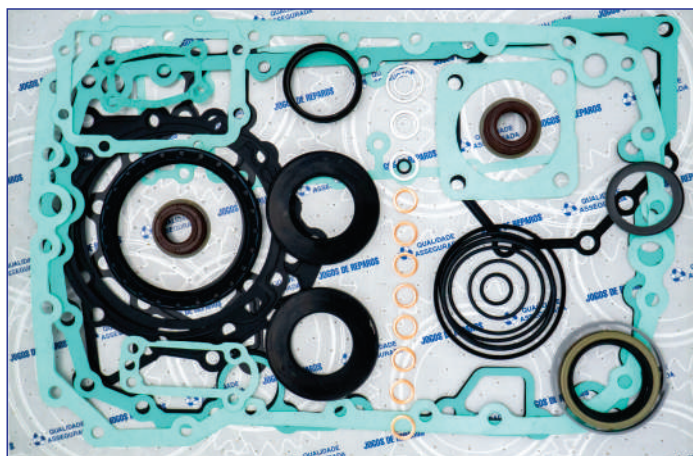

1315 298 003 – JOGO DE REPARO COMPLETO
16S221, 16S1585, 16S1685, 16S2280, 16S2320

KITS DE REPARO PARA TRANSMISSÃO

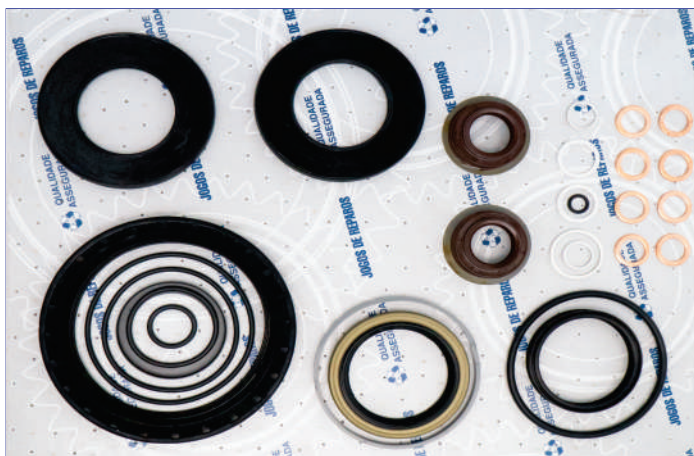

DP036 – JOGO DE REPARO PARCIAL
16S221, 16S1585, 16S1685, 16S2280, 16S2320



DP039 – JOGO DE REPARO DA TRANSFERÊNCIA
16S221, 16S1585, 16S1685, 16S2280, 16S2320



DP041 – JOGO DE REPARO SERVO SHIFT
16S221, 16S1585, 16S1685, 16S2280, 16S2320



DP038 – JOGO DE REPARO DA REDUZIDA
16S221, 16S1585, 16S1685, 16S2280, 16S2320

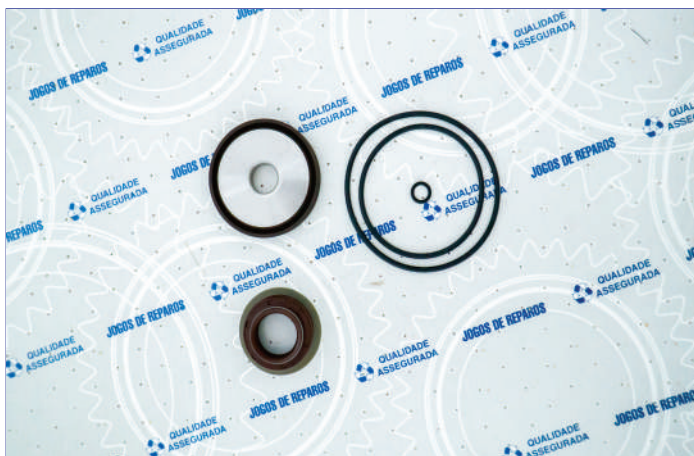

DP062 – JOGO DE REPARO DA REDUZIDA C/ EMBOLO
16S221, 16S1585, 16S1685, 16S2280, 16S2320

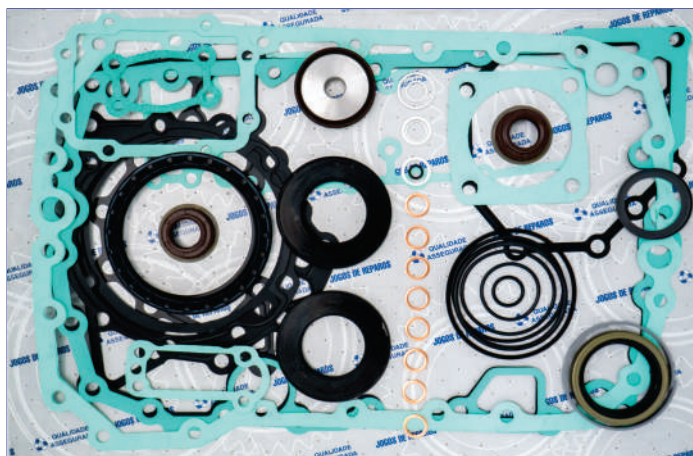

DP065 – JOGO DE REPARO COMPLETO COM EMBOLO
16S221, 16S1585, 16S1685, 16S2280, 16S2320

KITS DE REPARO PARA TRANSMISSÃO



**1295 298 932 – JOGO DE REPARO DA TRANSFERÊNCIA
8S-1350, 16S1300, 16S1455 16S1600,
16S1650, 16S1900**

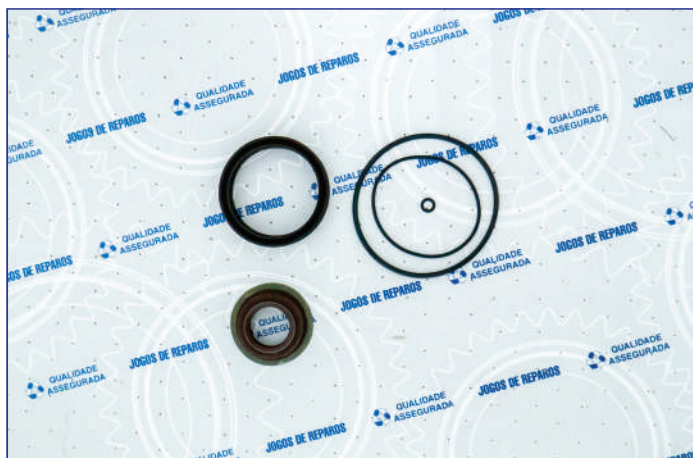

**1295 298 933 – JOGO DE REPARO DA REDUZIDA
8S-1350, 16S1300, 16S1455 16S1600,
16S1650, 16S1900**

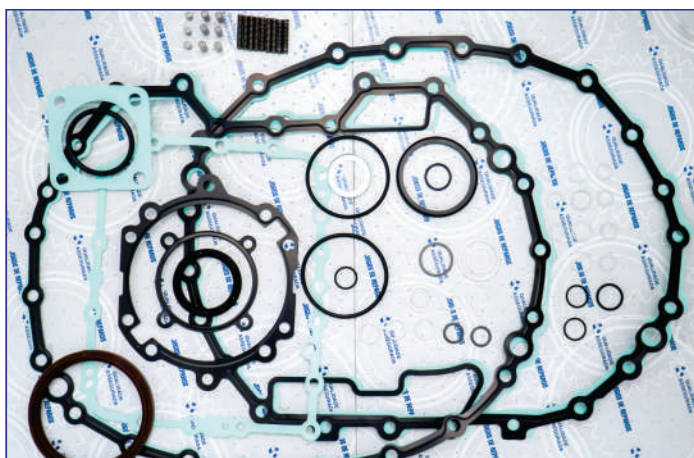

**1328 298 017 – JOGO DE REPARO COMPLETO
12AS1930, 12AS2130, 12AS2530, 12AS2540,
16AS2230, 16AS2630, 16AS2631**

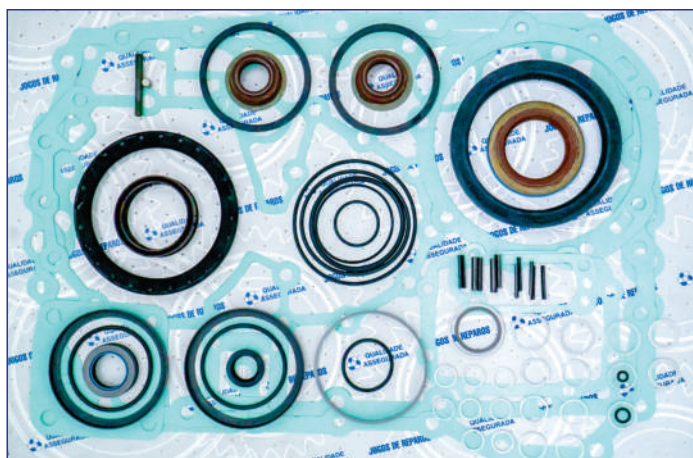

**DP058 – JOGO DE REPARO COMPLETO
16S1455**



**DP067 – JOGO DE REPARO COMPLETO (PAPEL)
12AS1930, 12AS2130, 12AS2530, 12AS2540,
16AS2230, 16AS2630, 16AS2631**



**DP087 – JOGO DE JUNTAS (METAL)
12AS1930, 12AS2130, 12AS2530, 12AS2540,
16AS2230, 16AS2630, 16AS2631**

KITS DE REPARO PARA TRANSMISSÃO



**1285 298 887 – JOGO DE REPARO PARCIAL
4K 120-GP / 4K 121-GP / 4S 120-GP**

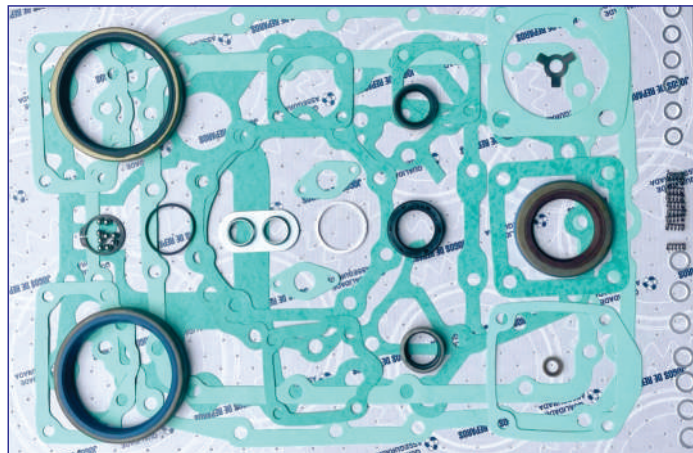

**1285 298 885/887 - JOGO DE REPARO COMPLETO
4K 120-GP / 4K 121-GP / 4S 120-GP**

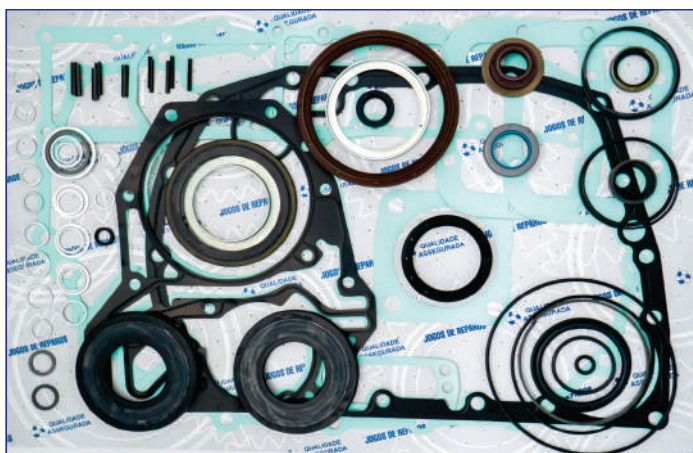

**1324 298 010 – JOGO DE REPARO COMPLETO
9S-1110**



**DP075– JOGO DE REPARO COMPLETO (PAPEL)
9S-1110**

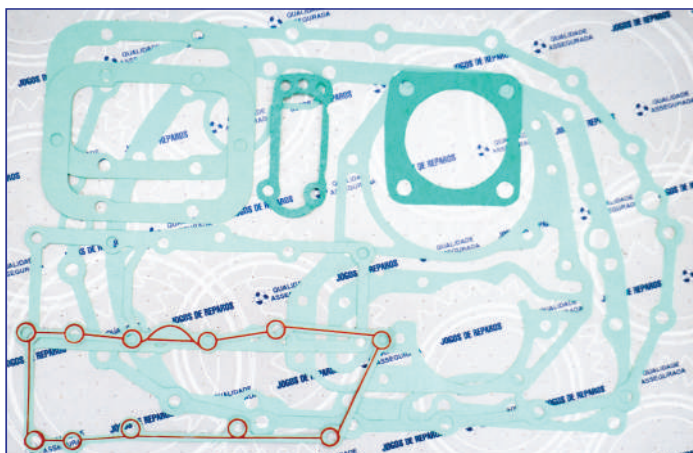

**DP056 – JOGO DE JUNTAS (PAPEL)
9S-1110**

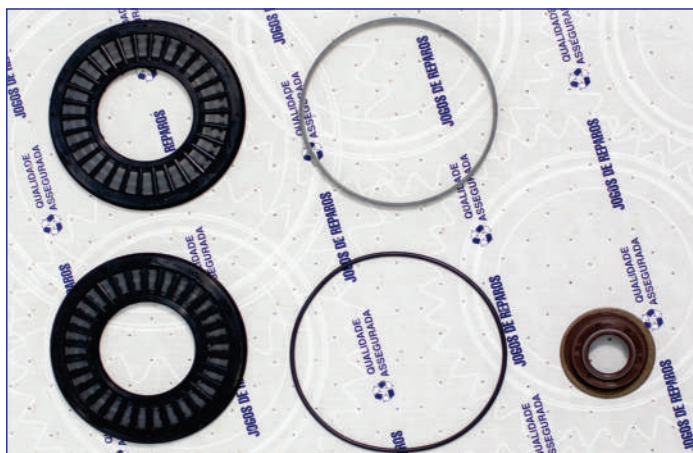

**DP 098 – JOGO DE REPARO PARCIAL
S6-90 / S6-1550**

KITS DE REPARO PARA TRANSMISSÃO

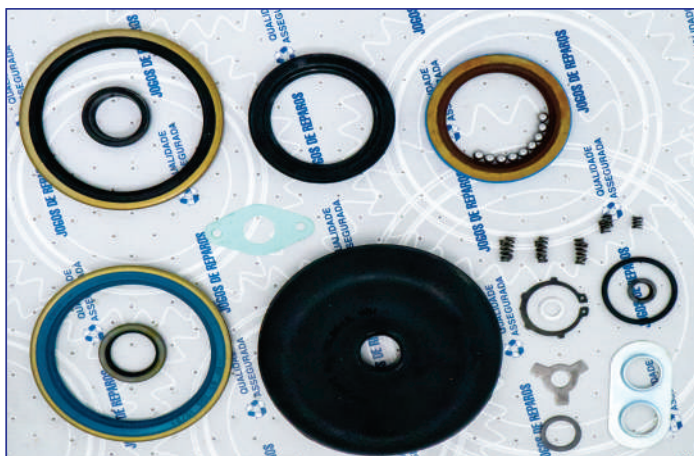

**1250 298 883 – JOGO DE REPARO PARCIAL
AK6-80**

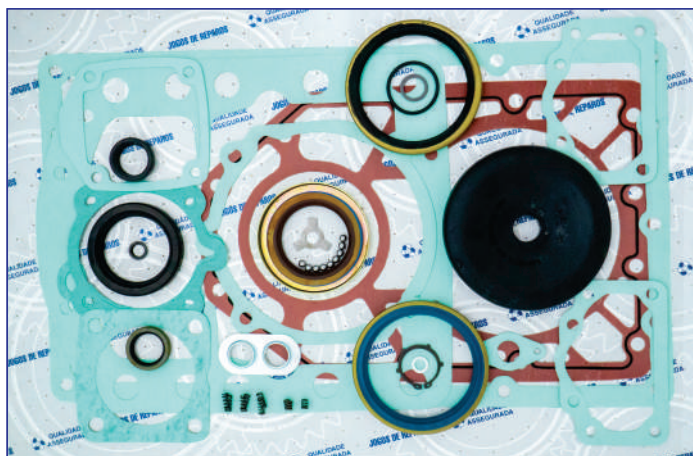

**1250 298 851 – JOGO DE REPARO COMPLETO
AK6-80**

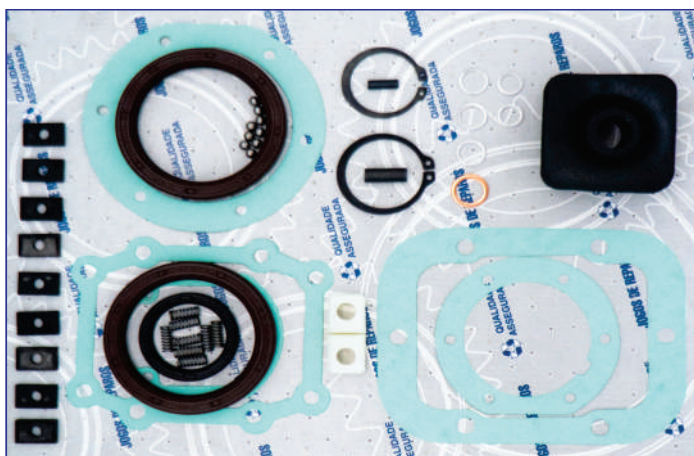

**1307 298 804 – JOGO DE REPARO COMPLETO
F 4000 F 450 S5420**

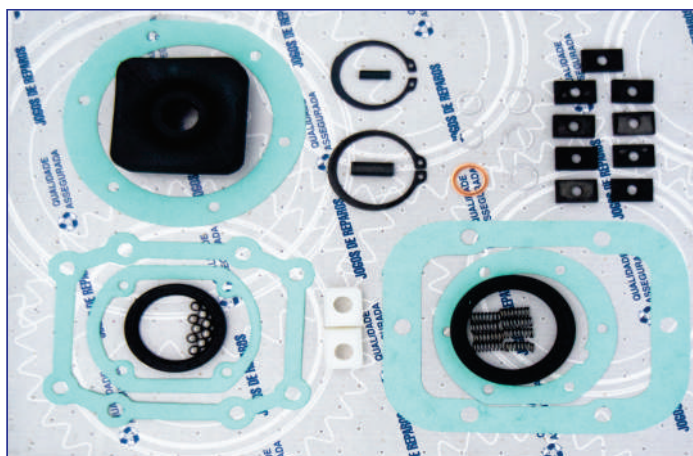

**1307 298 806 – JOGO DE REPARO COMPLETO
L0814 S5420**



**1308 298 801 – JOGO DE REPARO PARCIAL
9S-75**

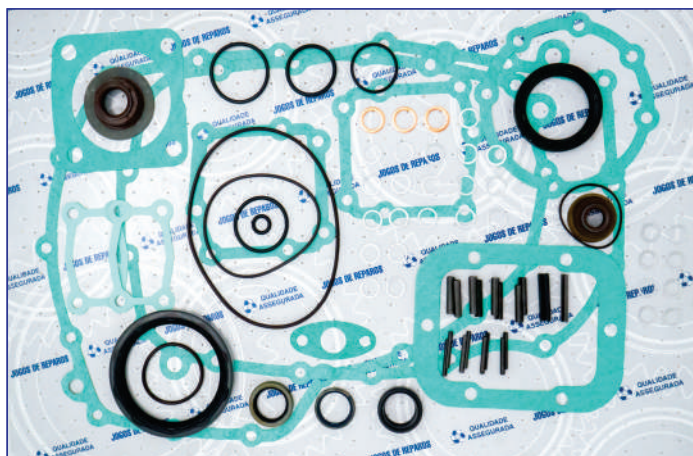

**1308 298 802 – JOGO DE REPARO COMPLETO
9S-75**

KITS DE REPARO PARA TRANSMISSÃO

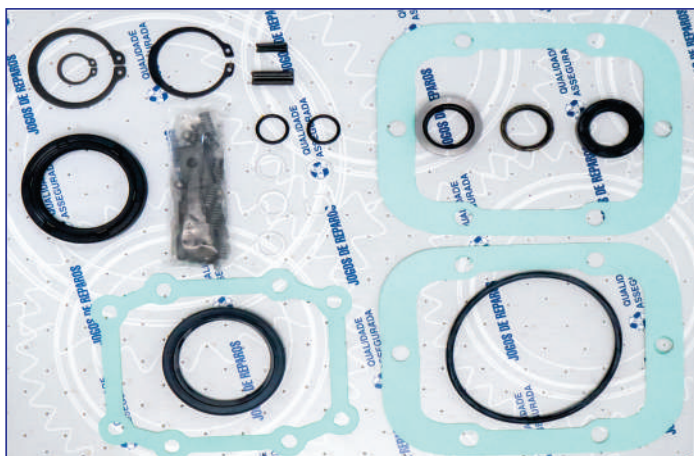

**1307 298 802 – JOGO DE REPARO COMPLETO
S5-42 712C/914C**

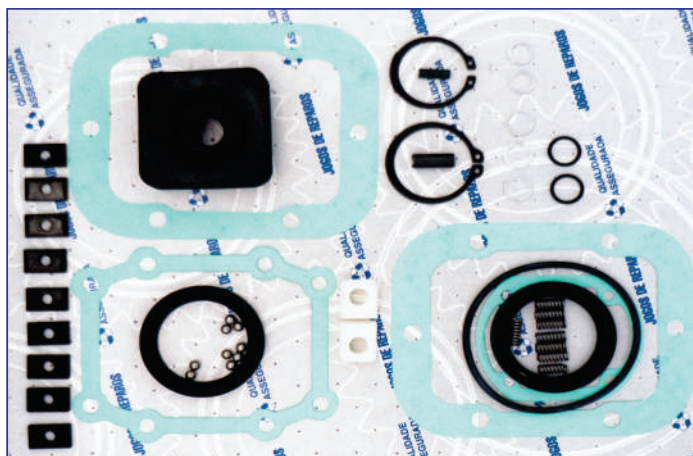

**1307 298 803 – JOGO DE REPARO COMPLETO
S5-42 L0914**

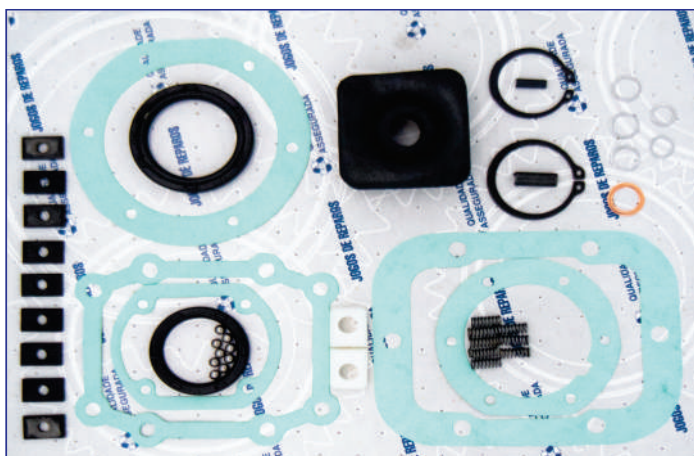

**1307 298 808 – JOGO DE REPARO COMPLETO
S5-420 L0812**

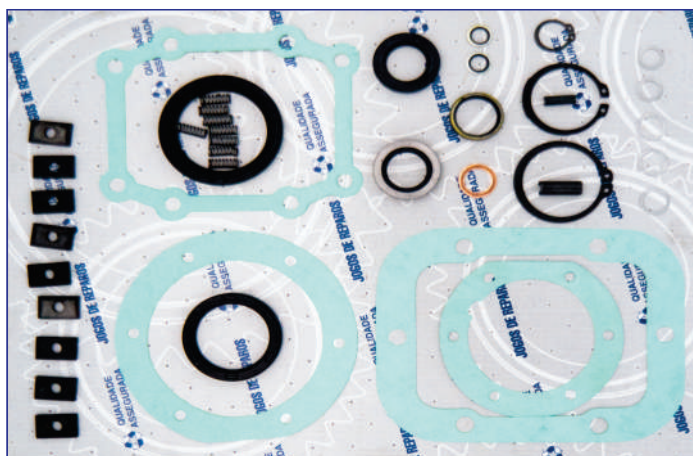

**1307 298 809 – JOGO DE REPARO COMPLETO
S5-420 8.120/8.150/9.150**

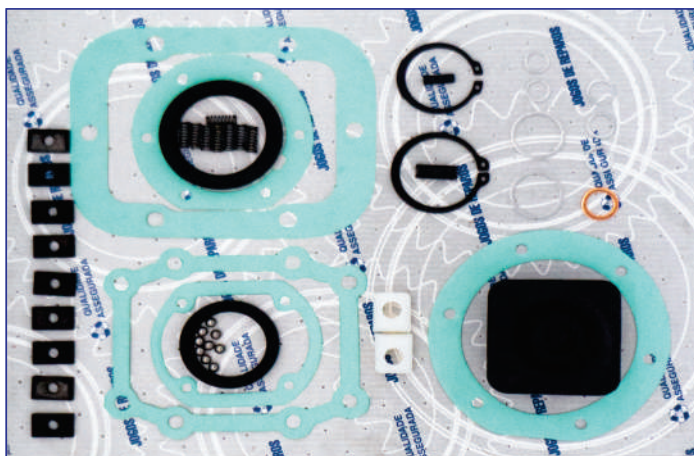

**1307 298 846 – JOGO DE REPARO COMPLETO
S5-420 D20 D6 SILVERADO 6-100/150 F-250/350**

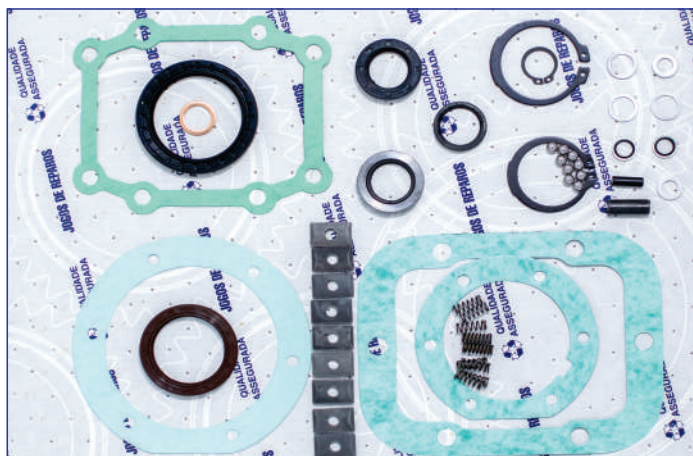

**1307 298 810 – JOGO DE REPARO COMPLETO
S5-420 8-150 E OD**

KITS DE REPARO PARA TRANSMISSÃO



**1268 298 847 – JOGO DE REPARO PARCIAL
S6-1550**

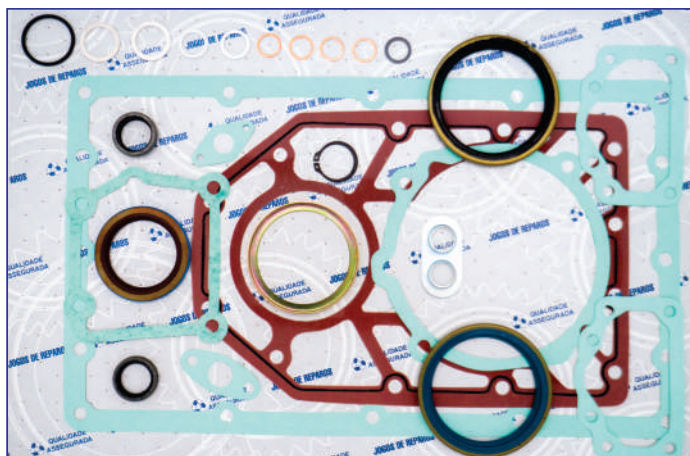

**1268 298 889/847 – JOGO DE REPARO COMPLETO
S6-1550**



**1290 298 865 – JOGO DE REPARO PARCIAL
S5-680**

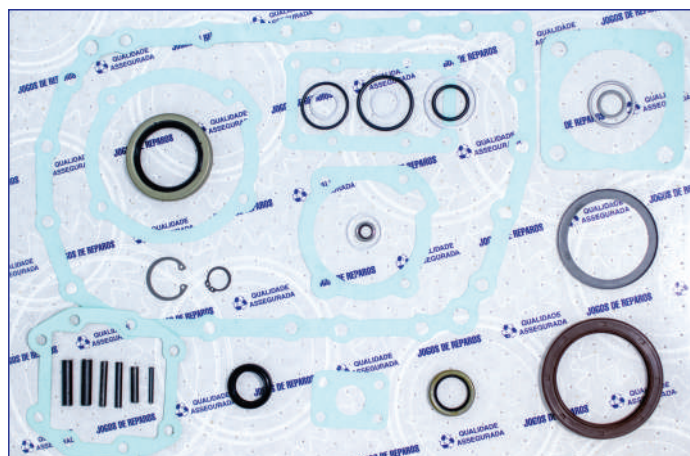

**1290 298 864/865 – JOGO DE REPARO COMPLETO
S5-680**

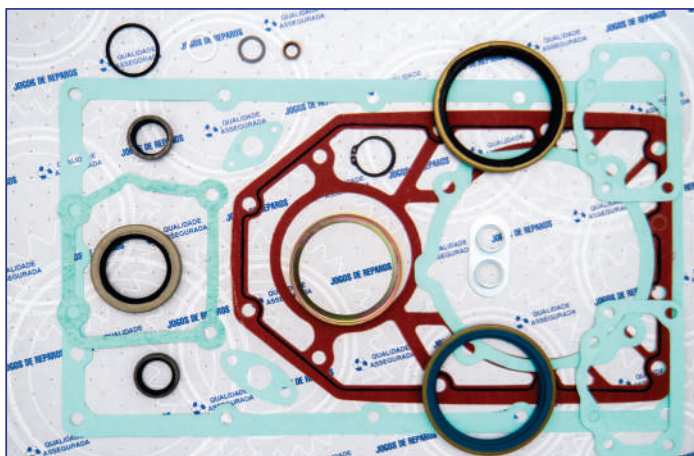

**1268 298 889/890 – JOGO DE REPARO COMPLETO
S6-90 / S6-1550**

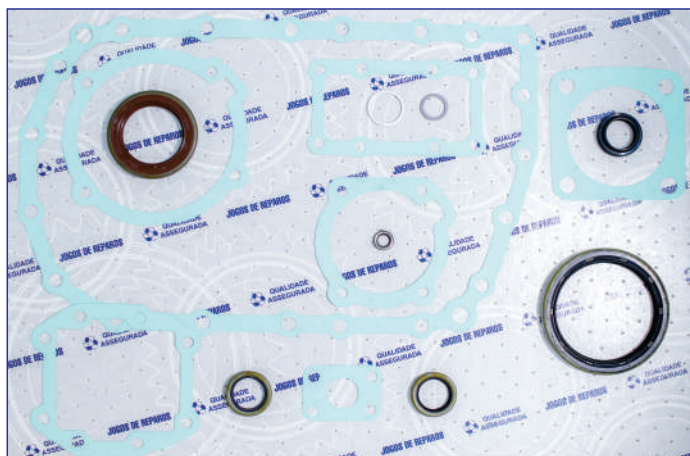

**1311 298 801 – JOGO DE REPARO COMPLETO
S5-820**

KITS DE REPARO PARA TRANSMISSÃO



**1268 298 890 – JOGO DE REPARO PARCIAL
S6-90 / S6-1550**

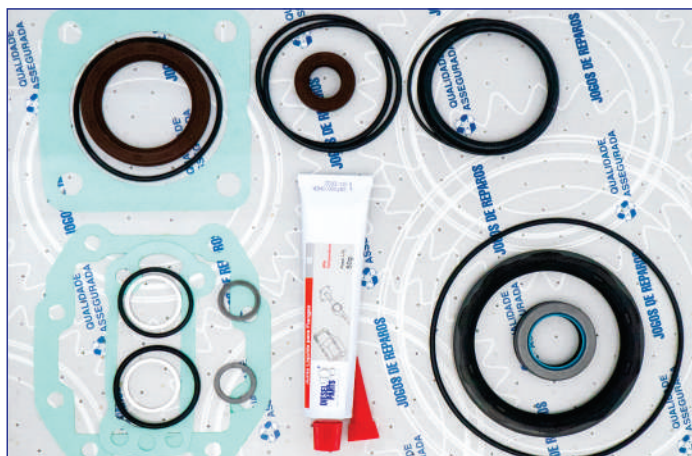

**DP059 – JOGO DE REPARO COMPLETO
6AS1010 B0**



**DP024 – JOGO DE REPARO DA TRANSFERÊNCIA
G210/240**



**DP025 – JOGO DE REPARO DA REDUZIDA
G210/240**



**DP035 – JOGO DE REPARO COMPLETO
G210/240**



**DP031 – JOGO DE REPARO COMPLETO
G131**

KITS DE REPARO PARA TRANSMISSÃO



**DP026 – JOGO DE REPARO COMPLETO
G60/85**



**DP032 – JOGO DE REPARO COMPLETO TRAMBULADOR
G210/240**



**DP045 – JOGO DE REPARO COMPLETO
G0-190**

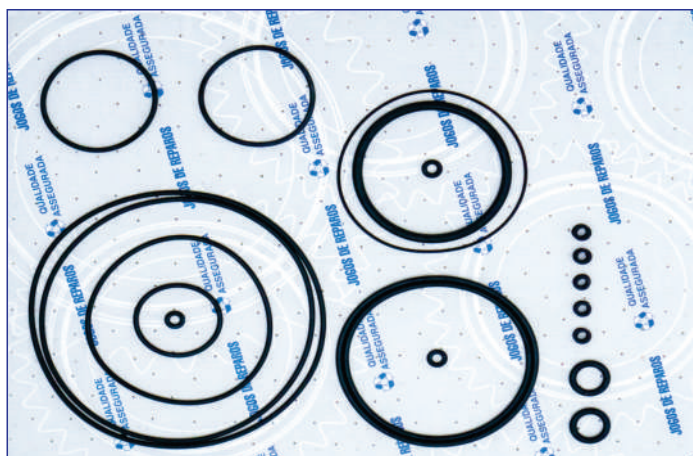

**DP050 – JOGO DE O-RINGS
G210/240**

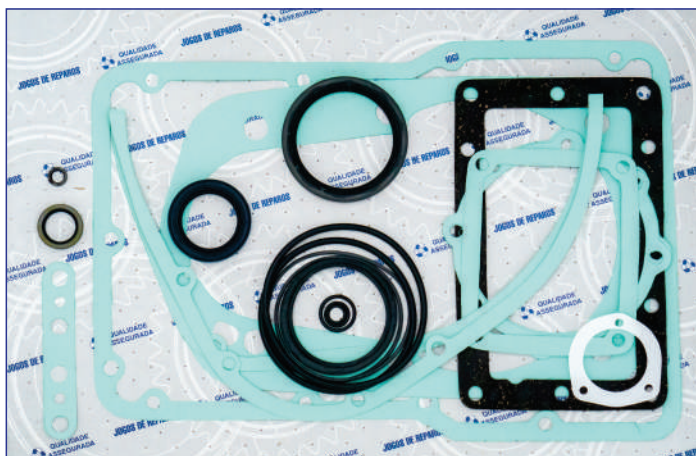

**DP023 284005 – JOGO DE REPARO COMPLETO
CAIXA SCANIA FLANGE GROSSA**

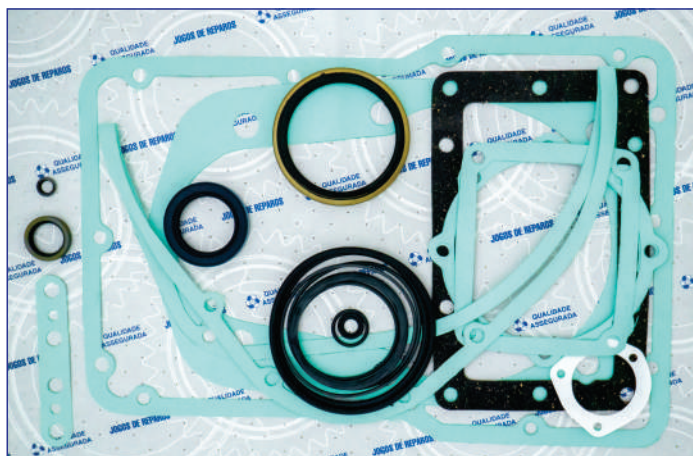

**DP023 124268 – JOGO DE REPARO COMPLETO
CAIXA SCANIA FLANGE FINA**

KITS DE REPARO PARA TRANSMISSÃO



**1900052 – JOGO DE REPARO DO RETARDER
GR 875 R, GRS 895 R, GR-GRS-GRSO 905 R,
GRSO 925 R**

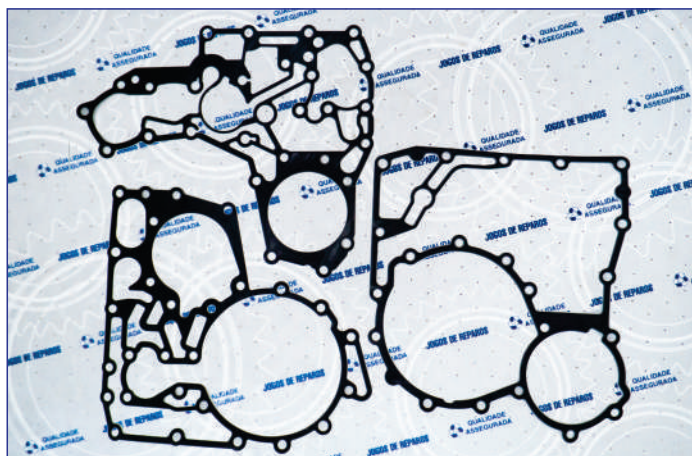

**DP095 – JOGO DE JUNTAS DO RETARDER
GR 875 R, GRS 895 R, GR-GRS-GRSO 905 R,
GRSO 925 R**

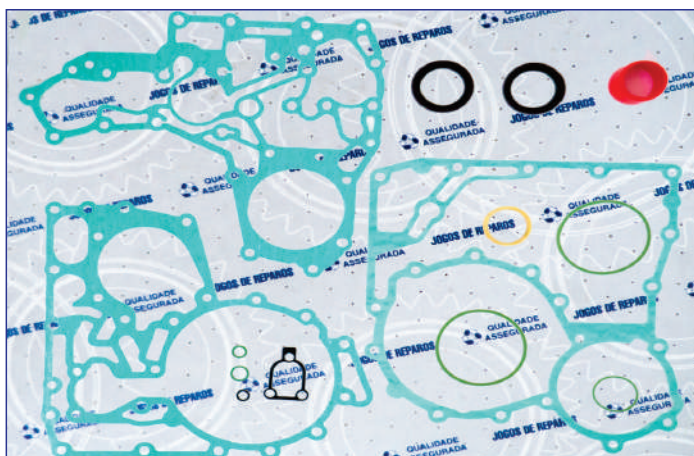

**DP094 – JOGO DE REPARO DO RETARDER (PAPEL)
GR 875 R, GRS 895 R, GR-GRS-GRSO 905 R,
GRSO 925 R**

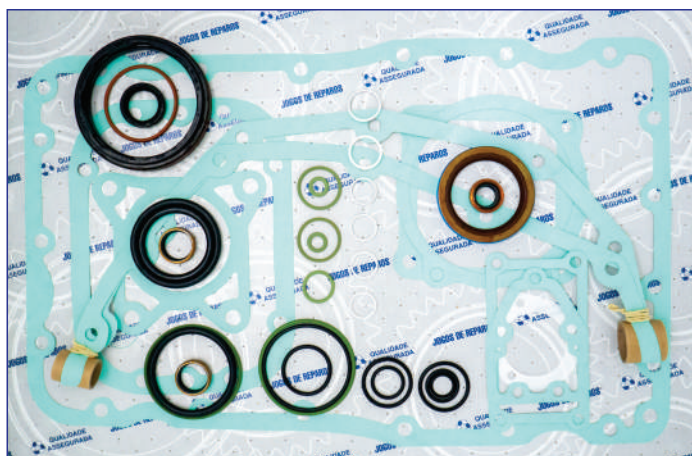

**DP053 – JOGO DE REPARO COMPLETO
GR/GRS900**

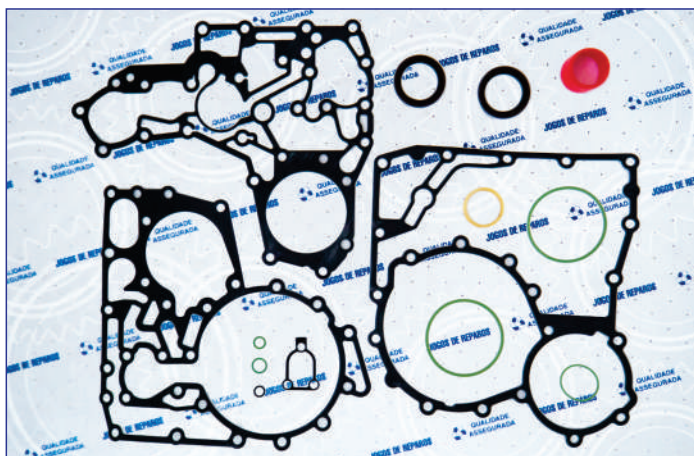

**DP068 – JOGO DE REPARO COMPLETO RETARDER (METAL)
GR 875 R, GRS 895 R, GR-GRS-GRSO 905 R,
GRSO 925 R**

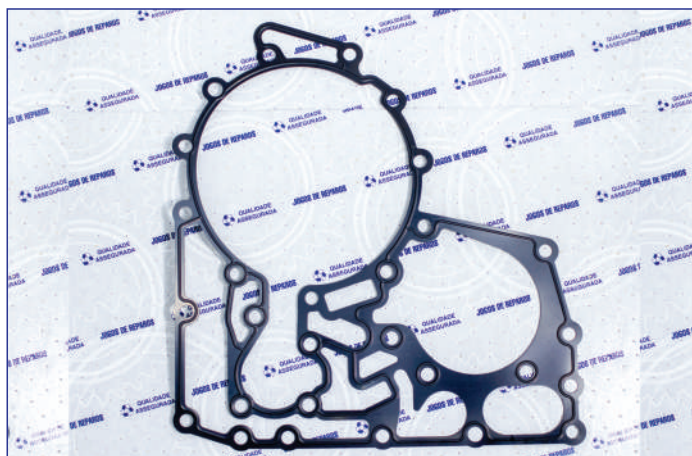

**1491103 – JUNTA DO RETARDER
GR 875 R, GRS 895 R, GR-GRS-GRSO 905 R,
GRSO 925 R**

KITS DE REPARO PARA TRANSMISSÃO

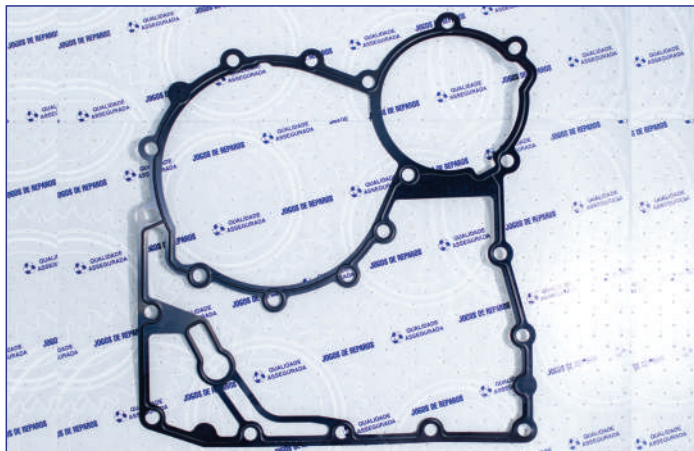

1766023 – JUNTA DO RETARDER
GR 875 R, GRS 895 R, GR-GRS-GRSO 905 R,
GRSO 925 R



1799371 – JUNTA DO RETARDER
GR 875 R, GRS 895 R, GR-GRS-GRSO 905 R,
GRSO 925 R



602591 – JOGO DE PRESSONADOR SINCRONIZAÇÃO
GR900



DP043 – JOGO DE REPARO DA REDUZIDA
GR/GRS900



DP044 – JOGO DE REPARO DA TRANSFERÊNCIA
GR/GRS900



DP055 – JOGO DE REPARO COMPLETO
GR/GRS905

KITS DE REPARO PARA TRANSMISSÃO

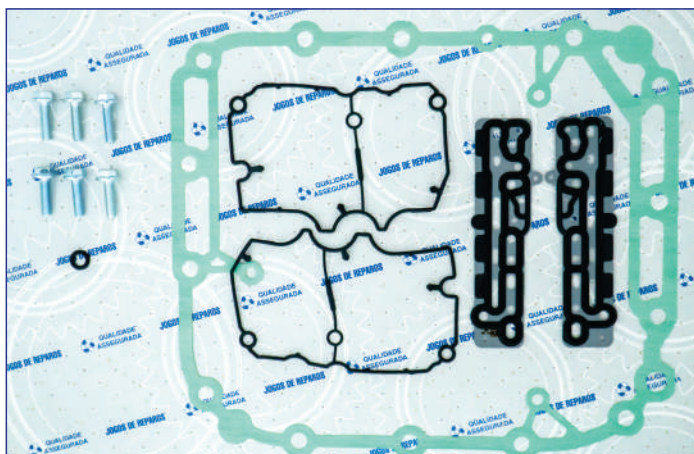

20785252 – JOGO DE REPARO TAMPA I-SHIFT

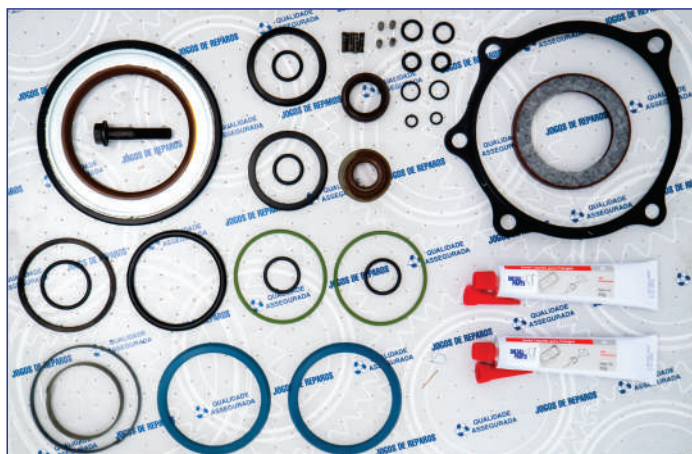

DP046 – JOGO DE REPARO COMPLETO VT2514 COM RETENTOR 20791305 - 95X145X10

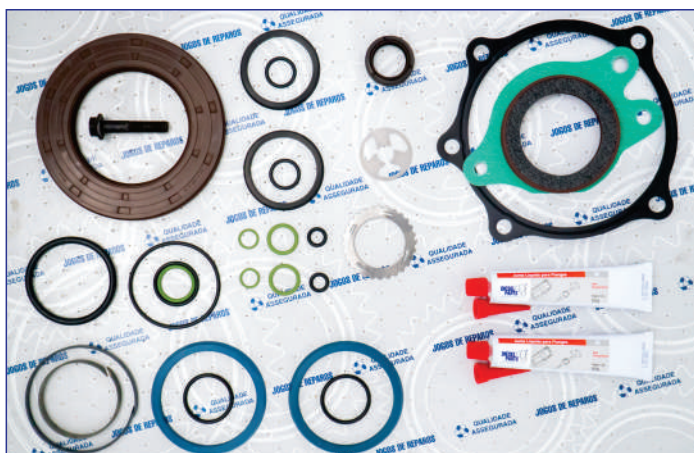

DP048 – JOGO DE REPARO COMPLETO SR1700/1900



DP051 – JOGO DE REPARO COMPLETO G8

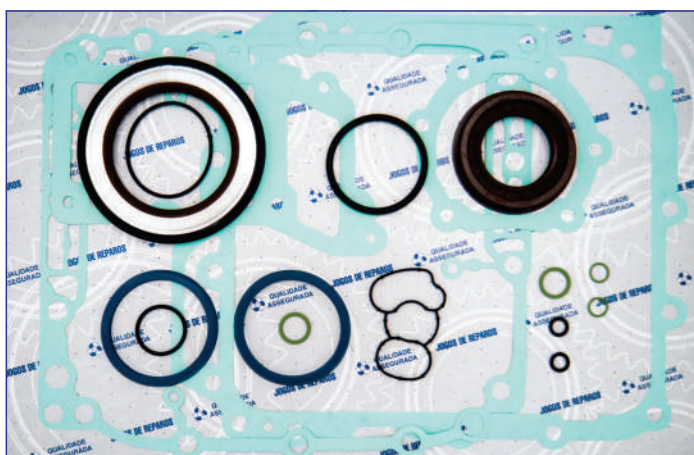

DP052 – JOGO DE REPARO COMPLETO I-SHIFT AT 2412C, AT/ATO 2512C, AT/ATO 2612D, AT 2812C/D, ATO 3112C/D

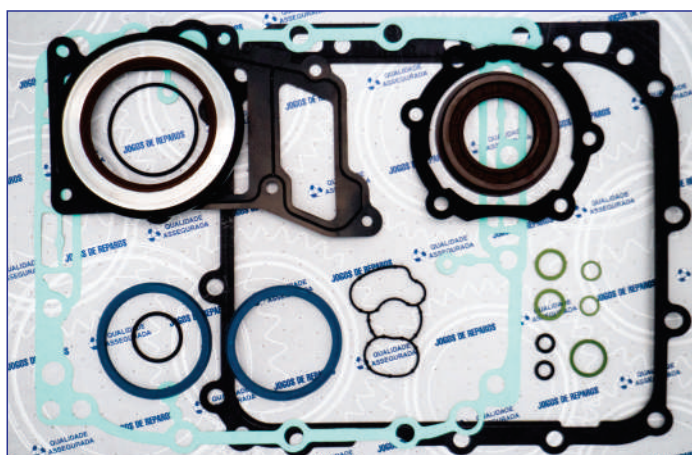

DP054 – JOGO DE REPARO COMPLETO I-SHIFT (METAL) AT 2412C, AT/ATO 2512C, AT/ATO 2612D, AT 2812C/D, ATO 3112C/D

KITS DE REPARO PARA TRANSMISSÃO

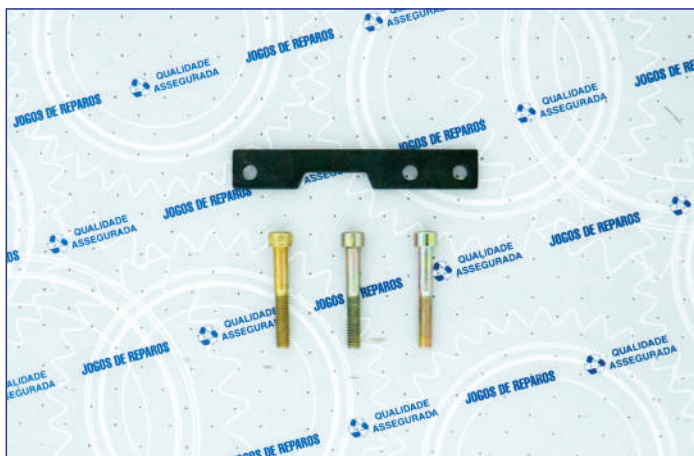

20845917 – BARRA DE APOIO
FH 12 2001-2005, FM 9 2001-2005,
FM 12 2001-2005



3092575 – JOGO DE REPARO DA REDUZIDA
VOLVO VT

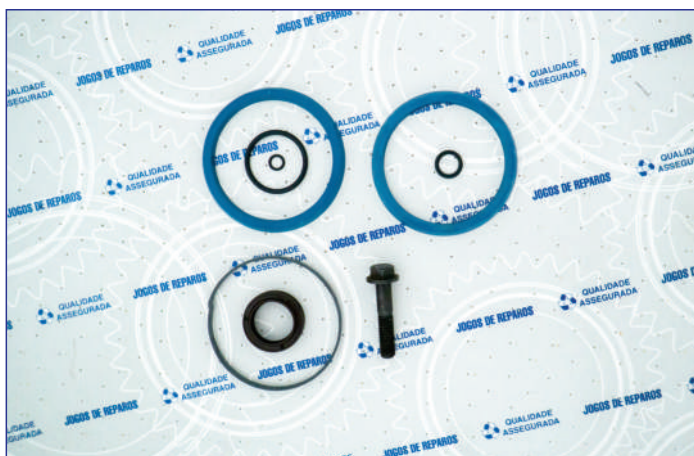

3093230 – JOGO DE REPARO DA TRANSFERÊNCIA
VOLVO VT

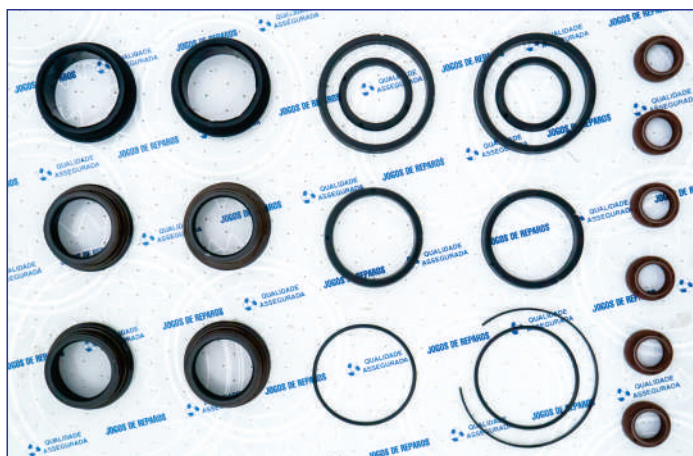

20562630 – JOGO DE REPARO DA CANECA
AT 2412C/D, AT/ATO 2512C, AT/ATO 2612C/D,
AT 2812C/D, ATO 3112C/D

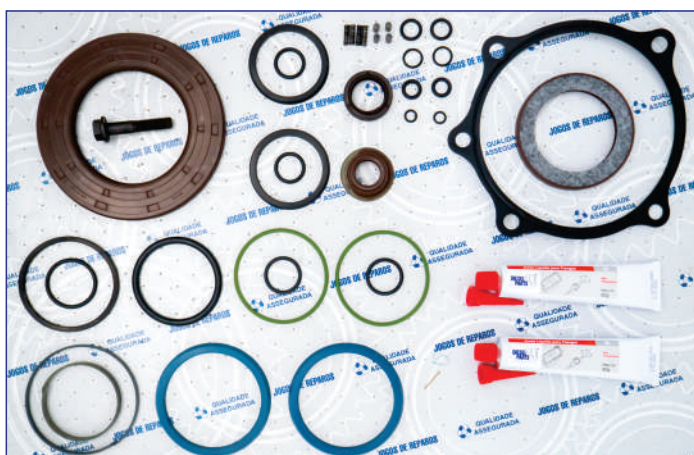

DP042 – JOGO DE REPARO COMPLETO
VT2014/VT2214 COM RETENTOR
1652276 - 90X145X10

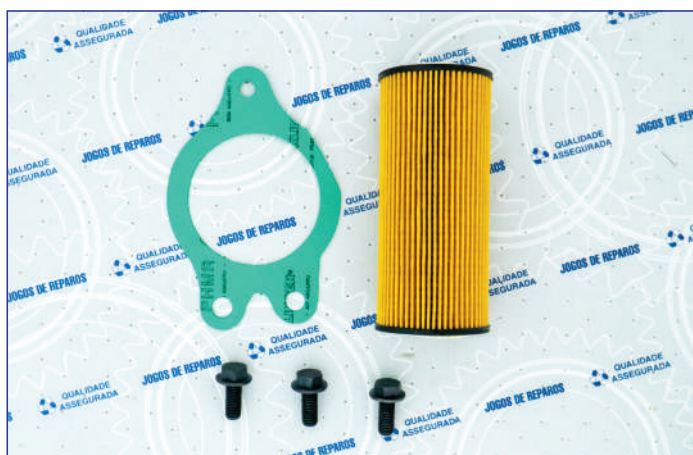

21479106 – KIT FILTRO
VOLVO VT

KITS DE REPARO PARA TRANSMISSÃO

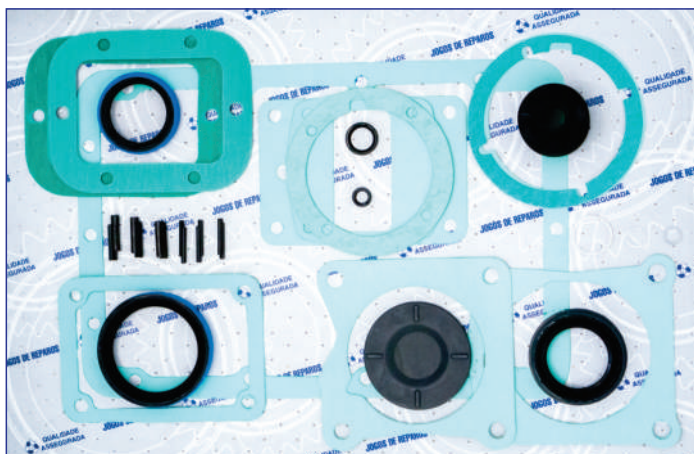

DP009 – JOGO DE REPARO COMPLETO
FS5005 - FS5205 - FSB5305



DP064 – JOGO DE REPARO COMPLETO
6209

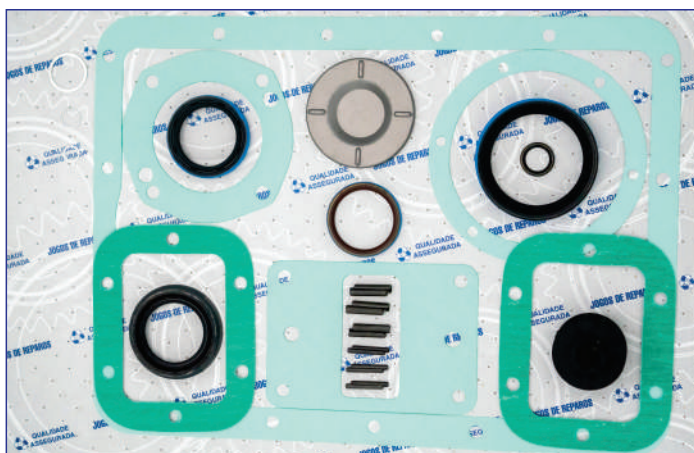

DP071 – JOGO DE REPARO COMPLETO
FS5306 - FSB5405 - FS5406 - FSB5406 - FS6005
FS6205 - FS6206 - FSB6206



DP078 – JOGO DE REPARO COMPLETO
FTS16108

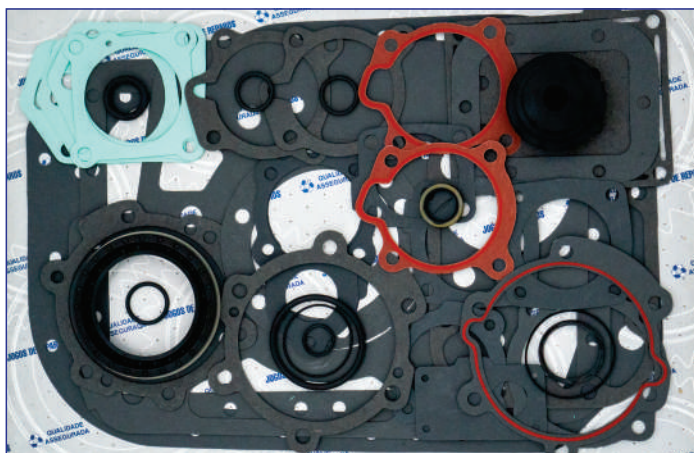

DP080 – JOGO DE REPARO COMPLETO
RT8908/12913/14918



DP083 – JOGO DE REPARO COMPLETO
RT16112 / RT20112

KITS DE REPARO PARA TRANSMISSÃO

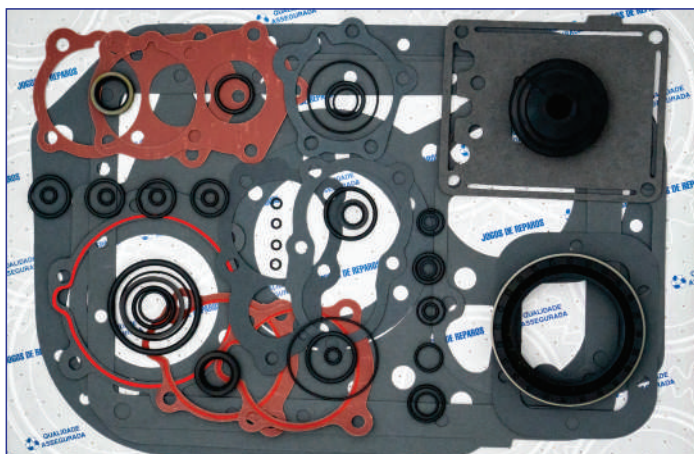

**DP057 – JOGO DE REPARO COMPLETO
FTS16112 / FTS20112**



**DP069 – JOGO DE REPARO COMPLETO
RT7608**



**DP074 – JOGO DE REPARO COMPLETO
RT11710**

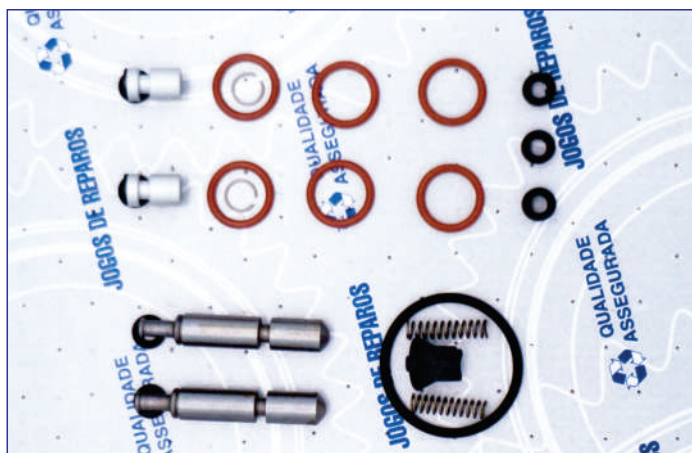

**DP089 – JOGO DE REPARO VÁLVULA TRANSFERÊNCIA
G210/240**

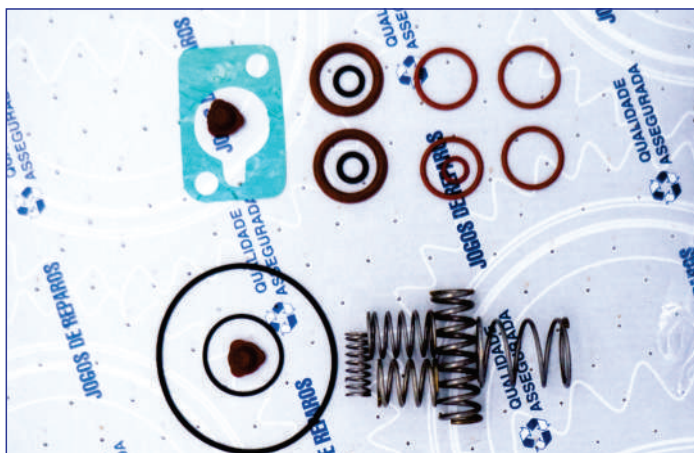

**DP090 – JOGO DE REPARO VÁLVULA 5/2 VIAS
16S1300 - 16S1600 - 16S1650**



**3092512 – REPARO DA VÁLVULA SPLIT
VOLVO SR 1400/1700/1900/2000/2400**

KITS DE REPARO PARA TRANSMISSÃO



**0501 396 632 – VÁLVULA DE 5/2 VIAS
16S1300 - 16S1600 - 16S1650**

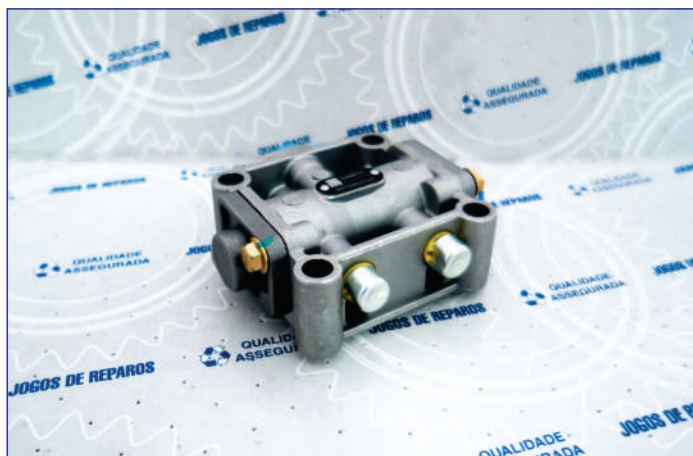

**0501 396 633 – VÁLVULA DE 5/2 VIAS
16S1300 - 16S1600 - 16S1650**



**6038 202 043 - VÁLVULA - 16S1650 - 16S221
9S1110 - 9S1310 - 9S1315 - 16S-2520 - 16S2521
16S2320 - 26S2321 - 16S1685 - 16S2280**



**6038 202 003 – VÁLVULA
16S1300 16S1600 16S1650 16S1900 8S1350**

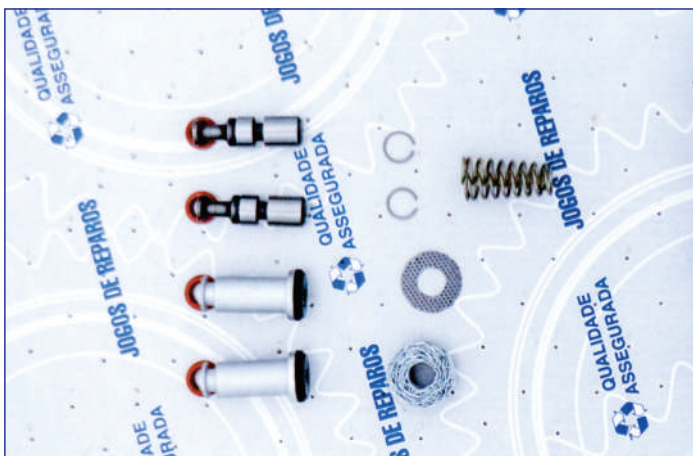

**DP091 – JOGO DE REPARO VÁLVULA TRANSFERÊNCIA
16S221**



**DP010 35 003 – JOGO DE REPARO VÁLVULA TRANSFERÊNCIA
16S1300 - 16S1600 - 16S1650**

KITS DE REPARO PARA TRANSMISSÃO



001 260 4963 – CILINDRO DE COMANDO
G 131/210/211, G 221/230/231, G 240/260



002 260 6157 – VÁLVULA DESLIGAMENTO / TRANSFERÊNCIA
G 131/210/211, G 221/231/240, G 260 ATEGO
1/2 G 131-9, G 211-16 ECONIC 1 G 211-16



0501 215 359 – VÁLVULA DE 5/2 VIAS
16S221, 16S2520TO, 16S2521TO,
16S2280TO, 16S2180TO

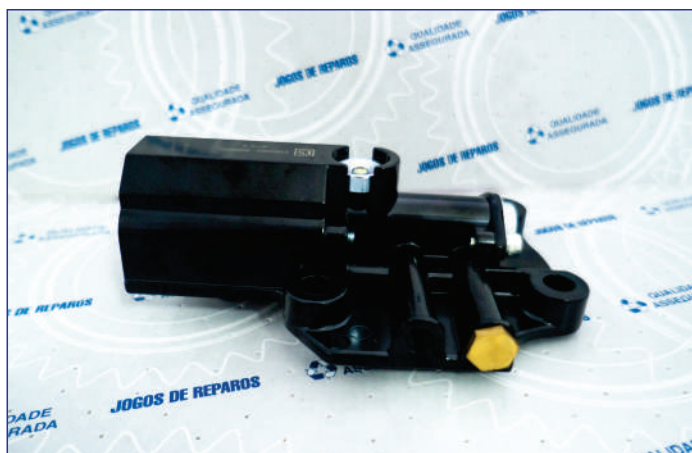

20590252 – VÁLVULA RAQUETE
GSS-RC /SRC, R/SR 1400/1500, R/SR 1700/1900,
VT 2014 /OD, VT 2214B, VT 2514



20775173 – VÁLVULA RELÊ
VT/VTO 2214 /B, VT 2514B



0501 310 059 – VÁLVULA DE 4/2 VIAS
MAN TGA/TGL/TGM/TGS/TGX/ IVECO

KITS DE REPARO PARA TRANSMISSÃO

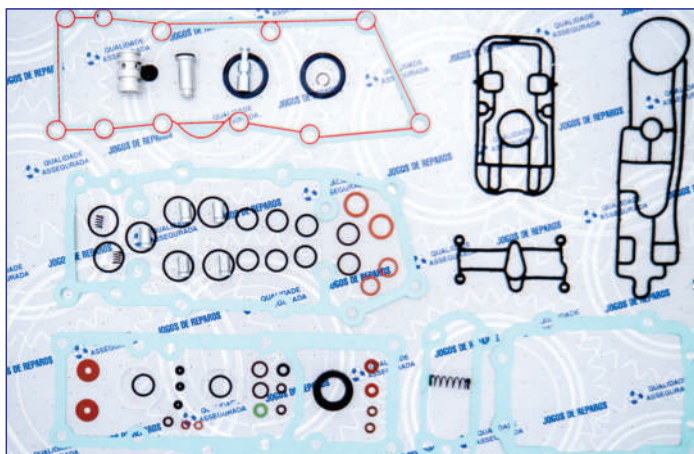

**DP079 – REPARO BLOCO DE VÁLVULAS
16S1455**

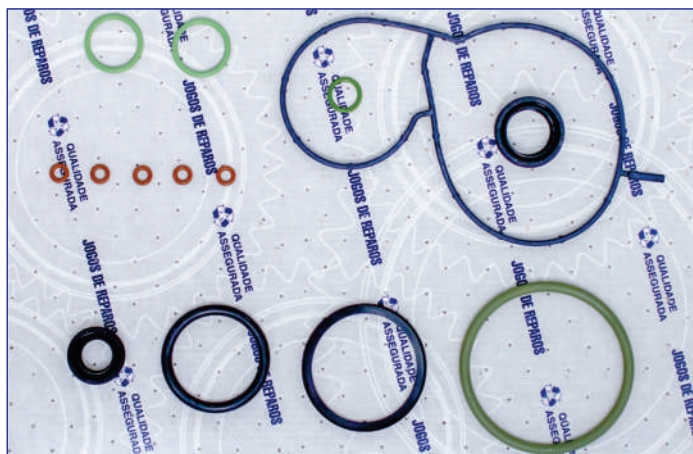

**1769778 - REPARO DA CANECA DA TRANSMISSÃO
GR 875 /R, GR 905 /R, GRS-GRSO 895 /R,
GRS-GRSO 905 /R**

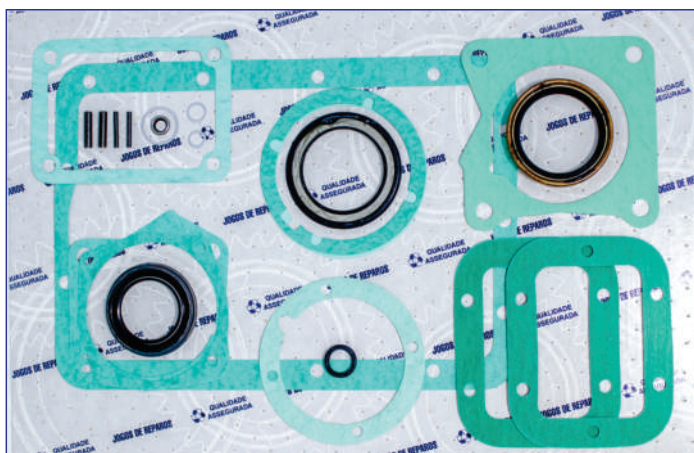

**DP013 - JOGO DE REPARO COMPLETO
FS4005**

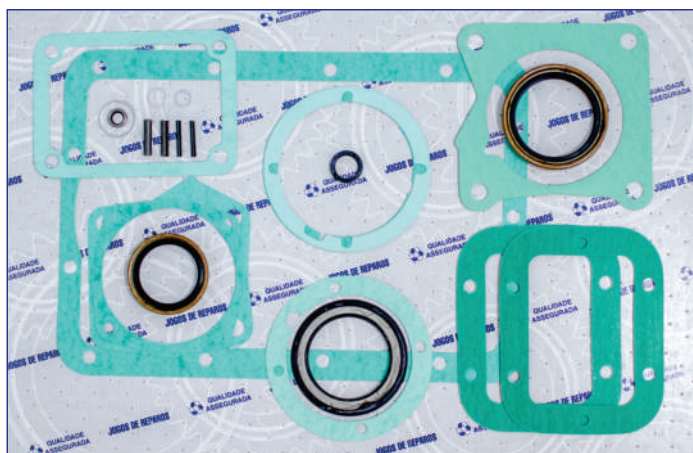

**DP014 - JOGO DE REPARO COMPLETO
FS4205**

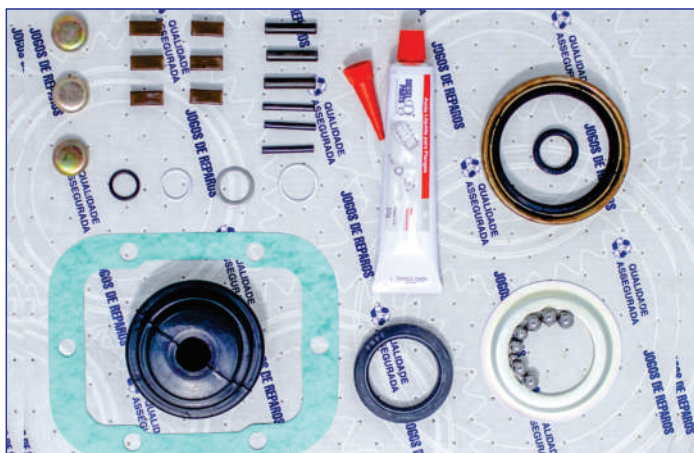

**DP097 - JOGO DE REPARO COMPLETO
FS4305 - FS4405**

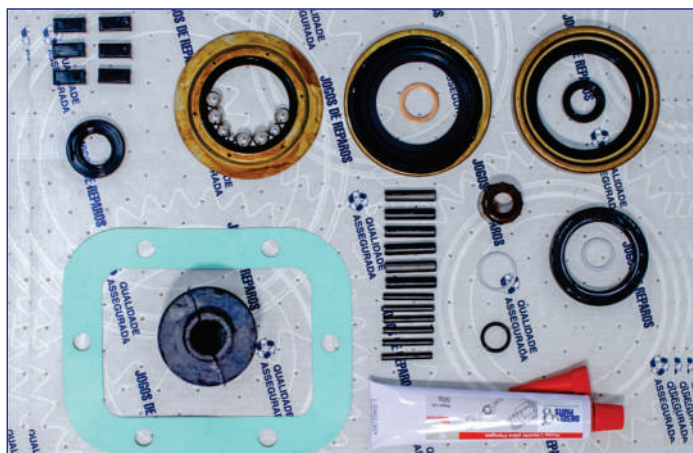

**DP100 - JOGO DE REPARO COMPLETO
FS4505**

KITS DE REPARO PARA TRANSMISSÃO

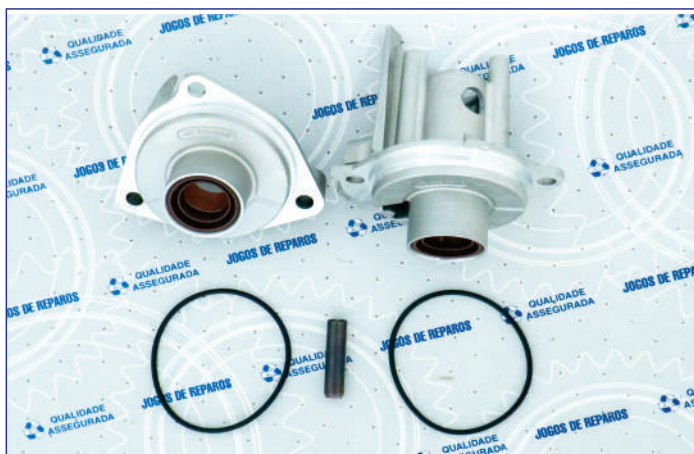

20562631 – JOGO DE REPARO DO COMANDO
FH 12 1998-2001, FM 9 2001-2005,
FM 12 2001-2005

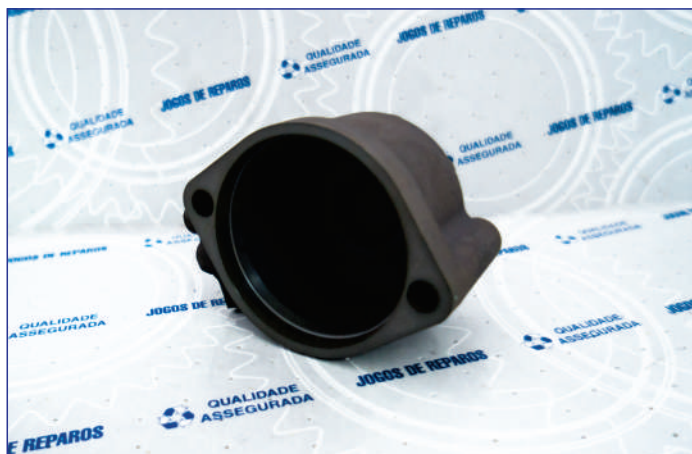

1484808 – CILINDRO TRANSFERÊNCIA
GR 801 /R, GRS 890 /R,
GR-GRS-GRSH 900 /R, GRS 920 /R



1521976 – CILINDRO DA REDUZIDA
VT 2014, VT/VTO 2214B, VT 2514B, VT 2514 /OD

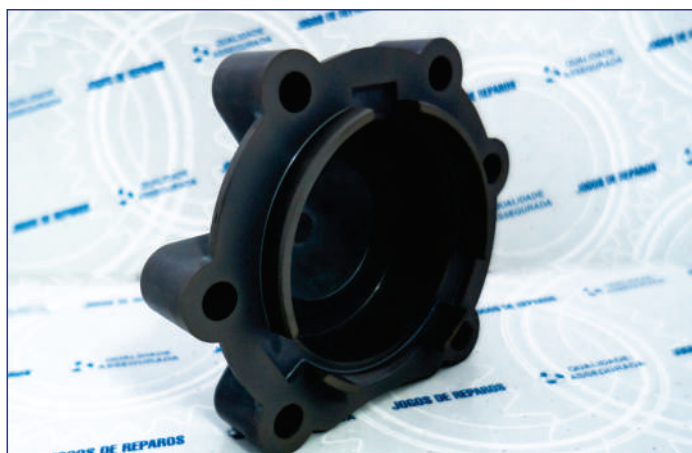

20483327 – TAMPA DO CILINDRO DA CAIXA FREIO
AT 2412C/D, AT/ATO 2512C, AT/ATO 2612D,
AT 2812C/D, ATO 3112C/D/E, ATO 3512D/E



20366642 - BUJÃO DO CILINDRO - AT 2412C/D, AT/ATO 2512C,
AT/ATO 2612D, AT 2812C/D, ATO 3112C/D, R/SR 1400/1700,
R/SR 1900, VT 1708B, VT 2009B, VT 2014 /OD, VT/VTO 2214 /B,
VT 2412B, VT 2514B, VT 2514 /OD



1656239 – CILINDRO DA TRANSFERÊNCIA
R/SR 1400/1700, R/SR 1900, VT/VTO 2014 /B,
VT/VTO 2214 /B, VT 2514B, VT 2514 /OD

KITS DE REPARO PARA TRANSMISSÃO



**1295 334 075 – CILINDRO DA TRANSFERÊNCIA
16S1300 - 16S1600 - 16S1650 - 16S1900**



**1296 312 042 – CILINDRO DA REDUZIDA
16S1300 - 16S1600 - 16S1650 - 16S1900**



**1315 334 069 – CILINDRO DA TRANSFERÊNCIA
16S221, 16S2220 TD, 16S2520 TO, 16S2521 TO,
16S2525TO, 16S2523 TO, 16S2320 TD,
16S2321 TD, 16S1685 TD, 16S2280 TO, 16S1585 TD**

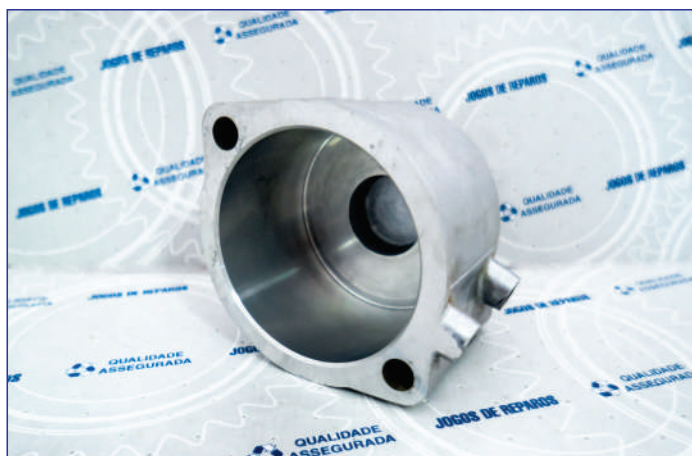

**284015 – CILINDRO DA REDUZIDA
GR 871, GRE 871T, GR 880 /T, GRH 880**



**1484809 – CILINDRO DA TRANSFERÊNCIA
GR 801, GR-GRS 900 /R, GRH 900**



**2181643 – CANECA DUPLA
F-/K-/N-SERIES GR 875 /R, GR 905 /R,
GRS-GRSO 895 /R, GRS-GRSO 905 /R**

KITS DE REPARO PARA TRANSMISSÃO



**389 260 0690 – BOMBA DE ÓLEO
G 200/210/211, G 221/231/240, G 260**



**1521900 – BOMBA DE ÓLEO
R 1500, R/SR 1400/1700, R/SR 1900,
VT 1708B, VT 2009B, VT 2014 /OD, VT/VTO 2214 /OD,
VT 2412B, VT 2514B, VT 2514 /OD**



**389 269 1606 - ENGRENAGEM DA BOMBA
O 300-/O 400-SERIES / O 500-SERIES
SETRA S 200-/S 300-SERIES**



**1521787 - ELEMENTO DA BOMBA - R 1500,
R/SR 1400/1700, R/SR 1900, VT 1708B, VT 2009B,
VT 2014 /OD, VT/VTO 2214 /OD, VT 2412B,
VT 2514B, VT 2514 /OD**



**389 269 1406 - ENGRENAGEM DA BOMBA
G 131/210/211, G 221/230/231,
G 240/241/260, G 280/281/330**



**389 269 0706 - ENGRENAGEM DA BOMBA
G 100/131/210, G 211/221/230,
G 231/240/241, G 260/280/281, G 330**

KITS DE REPARO PARA TRANSMISSÃO



**945 267 0819 – CILINDRO DA REDUZIDA
G 100/140/210, G 211/230/231,
G 240/241/260, G 280/281/330**



**945 267 1119 – CILINDRO DA TRANSFERÊNCIA
G 125/135/155/180, G 200/210/240**



**945 267 1319 – CILINDRO DA TRANSFERÊNCIA
G 131/210/211, G 221/230/231, G 240/260**



**1316 312 015 – CILINDRO DA REDUZIDA
16S221, 16S2220 TD, 16S2520 TO, 16S2521 TO,
16S2525TO, 16S2523 TO, 16S2320 TD, 16S2321 TD,
16S1685 TD, 16S2280 TO, 16S1585 TD**

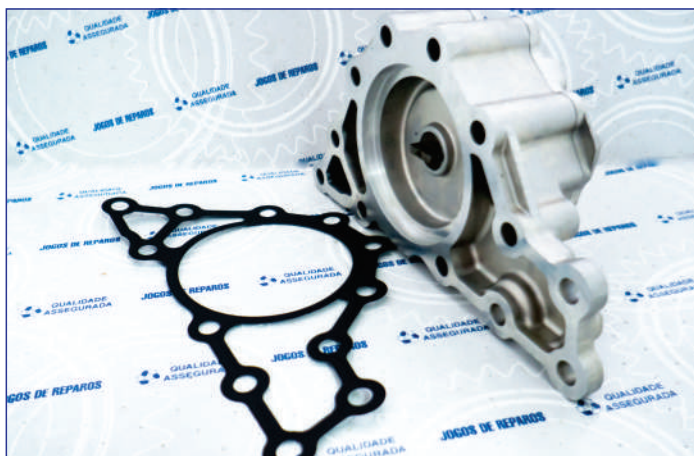

**2000570 – BOMBA DE ÓLEO
MAN TGA/TGL/TGM/TGS/TGX/DAF/IVECO**



**20567034 – BOMBA DE ÓLEO
AT 2412C/D, AT/ATO 2512C, AT/ATO 2612D,
AT 2812C/D, ATO 3112C/D**

KITS DE REPARO PARA TRANSMISSÃO



1297 202 072 – BOMBA DE ÓLEO
16S1300 16S1600 16S1650 16S1900
8S1350 16S1455



1426449 – BOMBA DE ÓLEO
G 670, GR 801 /R, GRS 890 /R,
GR-GRS-GRSO 900 /R, GR50H 901R, GRS 920 /R

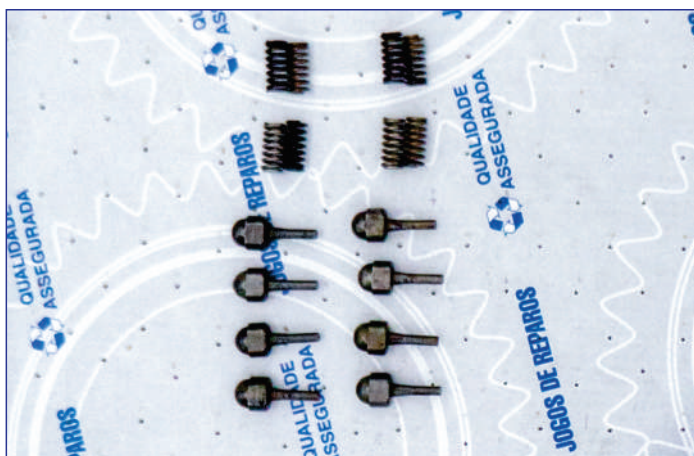

20847116 – JOGO DE PRESSIONADOR DAS MARCHAS
VT 1708B, VT 2009B, VT 2014, VT/VTO 2214B,
VT/VTO 2514B, VT 2514 /OD, VT/VTO 2814B



21141850 – JOGO DE PRESSIONADOR DA REDUZIDA
AT 2412C/D, AT/ATO 2512C, AT/ATO 2612D,
AT 2812C/D, AT 3112C/D, GSS-AGS /SRC, VT 2014,
VT/VTO 2214B, VT 2412B, VT 2514B, VT 2514 /OD

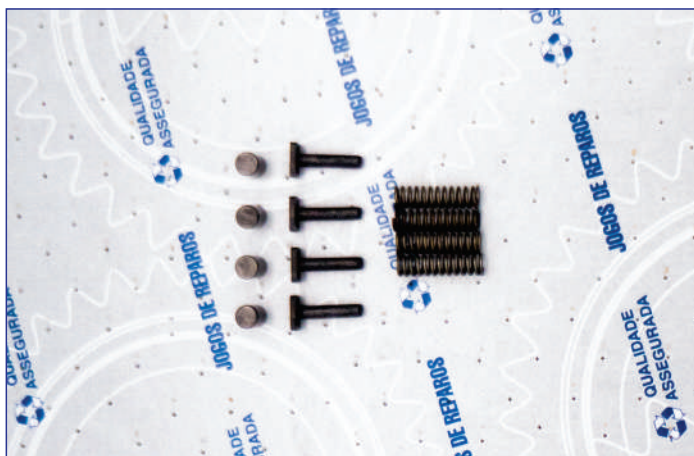

DP040 602593 – JOGO DE PRESSIONADOR SCANIA
GR 801 /R, GRS 890 /R, GR-GRS-GRSO 900 /R,
GRS 920 /R (369911X4, 369910X4, 374334X4)



DP047 – JOGO DE PRESSIONADOR
G60/85

KITS DE REPARO PARA TRANSMISSÃO

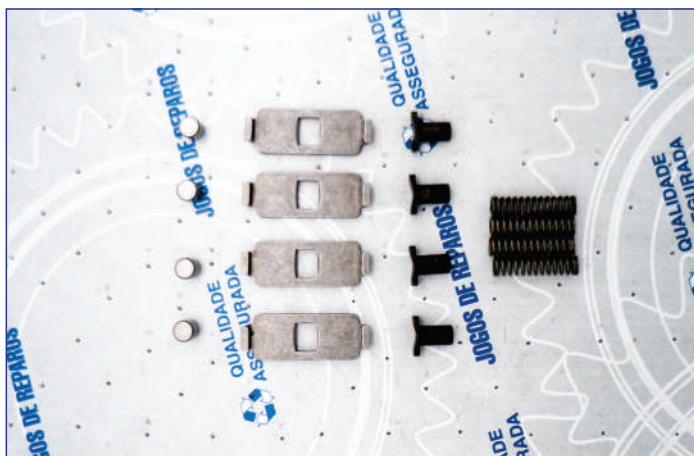

30890 – JOGO DE PRESSIONADOR DAS MARCHAS R/SR 1400/1700, R/SR 1900/2000, SRO 2000/2400 (1653900X4, 1653901X4, 1653994X4, 1668280X4)

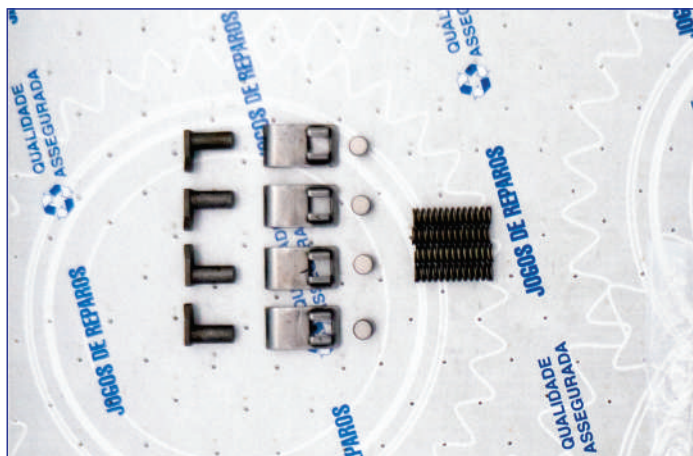

30891 – JOGO DE PRESSIONADOR DAS MARCHAS R/SR 1400/1700, R/SR 1900/2000, SRO 2000/2400 (1653900X4, 1653901X4, 1653983X4, 1653995X4)

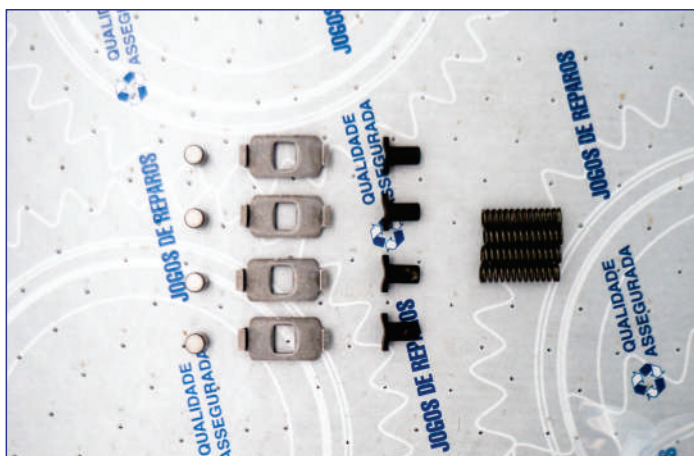

30892 – JOGO DE PRESSIONADOR DAS MARCHAS R/1000-1400-1500-1700-1900 (1653900X4, 1653990X4, 1653901X4, 1668280X4)

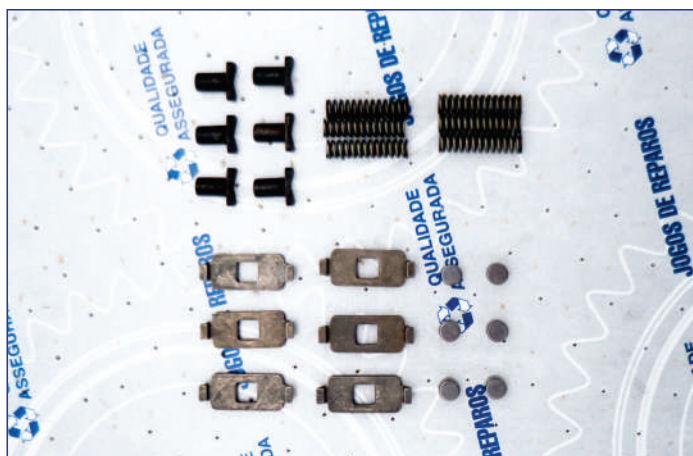

30894 – JOGO DE PRESSIONADOR DA REDUZIDA R/SR 1400/1700, R/SR 1900/2000, SRO 2000/2400 (1653904x6, 1653901x6, 1668280x6, 1653991x6)



1285 198 400 – JOGO DE PRESSIONADOR 4K 120-GP, 4S120-GP

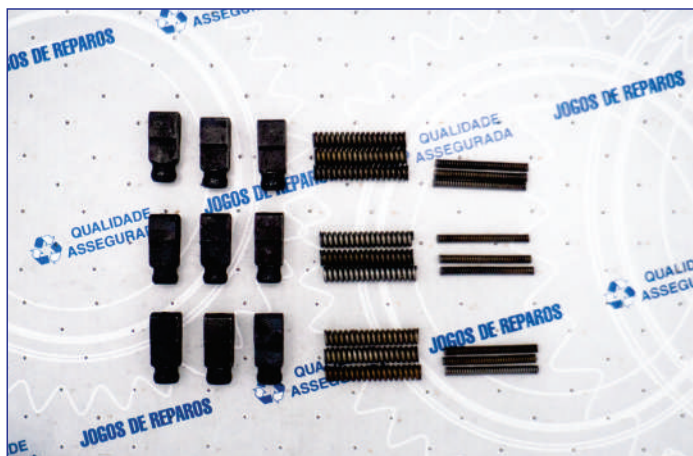

1250 198 400 – JOGO DE PRESSIONADOR S6-80, S6-90

KITS DE REPARO PARA TRANSMISSÃO

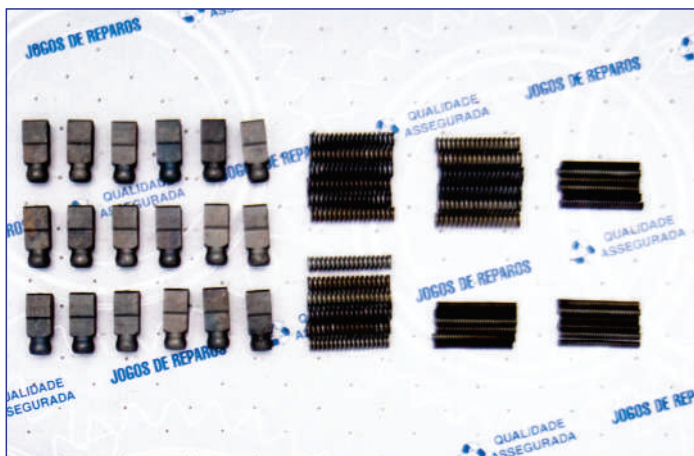

**1295 198 402 – JOGO DE PRESSIONADOR
16S1300, 16S1600, 16S1900**



**1297 198 400 – JOGO DE PRESSIONADOR
8S-1350, 16S1455, 16S1650, 16S2320,
16S1585, 16S1685, 16S2180, 16S2280**

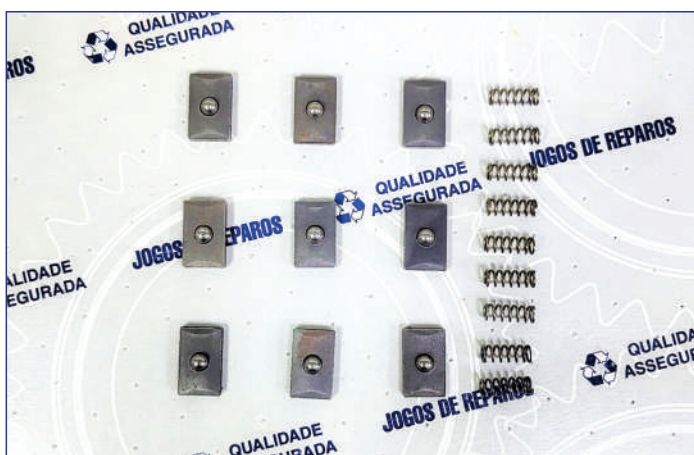

**1307 198 412 – JOGO DE PRESSIONADOR
S5-42, S5-420, 5S-580 BO/TO**



**1311 198 401 – JOGO DE PRESSIONADOR
S6-1550, S6-820**



**DP081 – JOGO DE PRESSIONADOR
6S-1010, 6AS-1010**



**1295 198 401 – JOGO DE PRESSIONADOR
9S1110 TD**

DIESEL PARTS

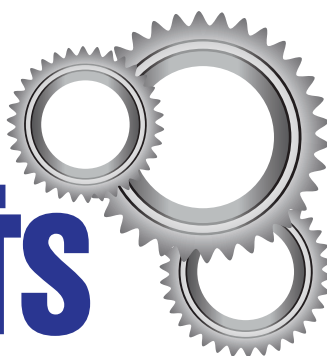

DIESEL PARTS PEÇAS AUTOMOTIVAS LTDA

55 15 3411.0934

Alameda Itanhaem, 391
Jd. Saira - Sorocaba / SP
CEP 18085-180
www.dparts.com.br

